



**OPERATOR'S MANUAL
FOR MODEL
88-023
BLADE GRINDER**

Table of Contents

	Page
Blade Grinder Safety and User Instructions	2
Unpacking the Grinder	5
Assembling the grinder	6
Adjusting the grinding angle	8
Adjusting the table plate	10
Grinding the blade	11
Balancing the blade	14
Grinder maintenance	15
Exploder view and Parts	16
Warranty	17

Blade Grinder Safety and User Instructions



Caution!!!

BEFORE USING THE BLADE GRINDER CAREFULLY FOLLOW THESE SAFETY PRECAUTIONS AND USER INSTRUCTIONS

1. Always check to see that the power switch is in the off position and the safety lock is removed anytime other than during use. If the power switch is not in the off position place it there and remove the safety lock pin from the switch.



2. Always place the grinder on a flat and level working surface making sure that it is properly supported.
3. Always check the working area to be sure that it is free from all flammables such as shop rags, gas cans, and other solvents. Frequently clean all grinding dust accumulations also.
4. Always check the area around the grinder to ensure that the grindings will not be directed at anyone or toward anything else that may be harmed.
5. Always make sure the area is free of any loose objects that could be caught in the grinding wheel.
6. Carefully inspect all aspects of the grinder.
 - Are there breaks in the insulation or exposed wires on the power cord?
 - Has the ground terminal on the cord been broken or damaged?
 - Are any of the guards missing or damaged?
 - Does the stone have cracks or is it chipped?
 - Are the paper blotters missing on one or both sides of the stone?
 - Is the stone rated for less than the maximum spindle speed of the grinder?
 - Is there unusual vibration that might indicate loose, cracked or otherwise damaged stone?
7. Never operate the grinder if any of the questions in #6 can be answered yes. If the answer to any of the items in #6 was yes unplug the unit and remove the lock from the power switch. Have the unit repaired or replaced before any further use .If replacing the stone test it for structural integrity for approximately 1 minute at full RPM with no grinding. Be sure to keep all bystanders clear of the area.
8. Always check the tongue guards for clearance. Those on the guard over the top of the wheel should be no more than $\frac{1}{4}$ " from the stone. The guard at the bottom connected to the work table should be no more than $\frac{1}{8}$ " from the stone.

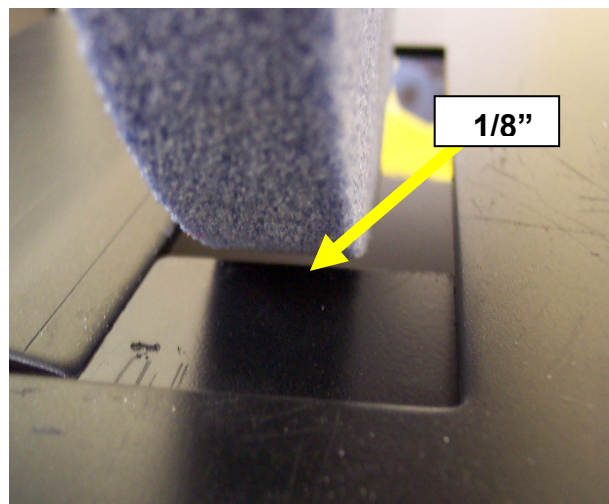
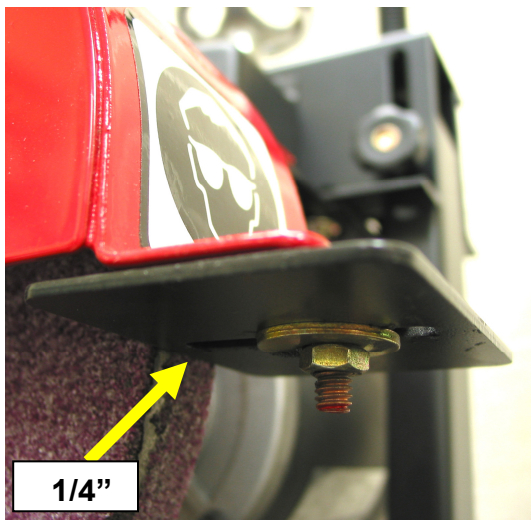

9. Never use the grinder if the clearances listed in #8 above are not correctly adjusted to these tolerances. Never adjust the guards without first checking to see that the power switch is in the off position and the lock is removed. Adjust the guards by first loosening the nuts holding the guards in place. Next slide the guard toward the stone to within the proper dimension. If you are unsure of this distance do not use the grinder. If the correct distance cannot be achieved due to stone wear do not use the grinder until the stone has been replaced. After you have confirmed that the tongue guards are properly adjusted you may continue.

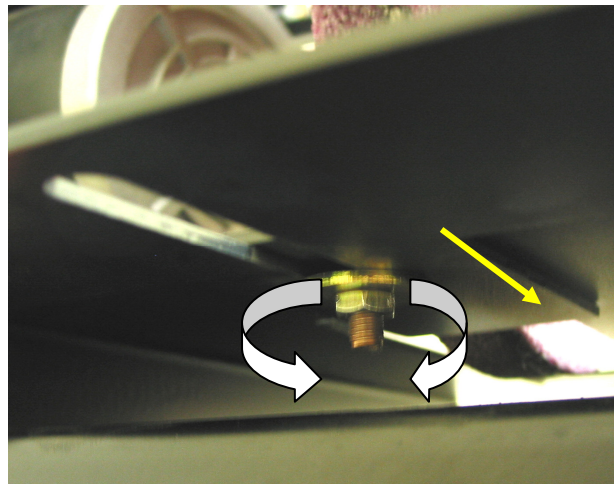
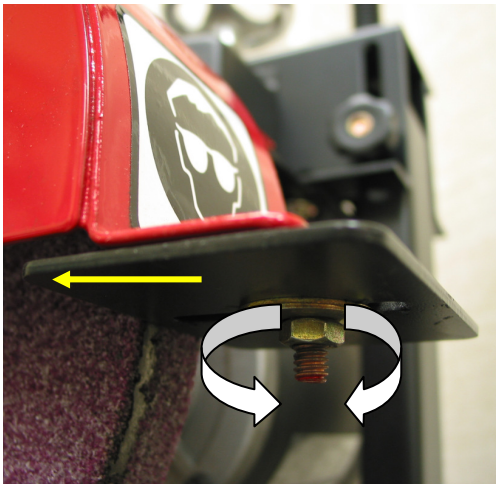

10. Always be sure that you have proper eye protection. A pair of safety glasses or a safety shield with the safety rating of Z87 must be worn at all times while grinding. (ANSI Z87.1-2003)

11. Always wear gloves and be cautious of sharp edges.

12. Never operate grinder while wearing loose clothing. Always make sure that long hair is pulled back so that it cannot be caught in grinding wheel.

13. Connect the power cord to a properly grounded 110/120 volt outlet.

Unpacking the grinder

Carefully remove the grinder and all components from the box. This should include the grinder plus 4 guards, hardware (4 nuts, 7 washers, and 3 plastic thumb screws) and 1 table plate.

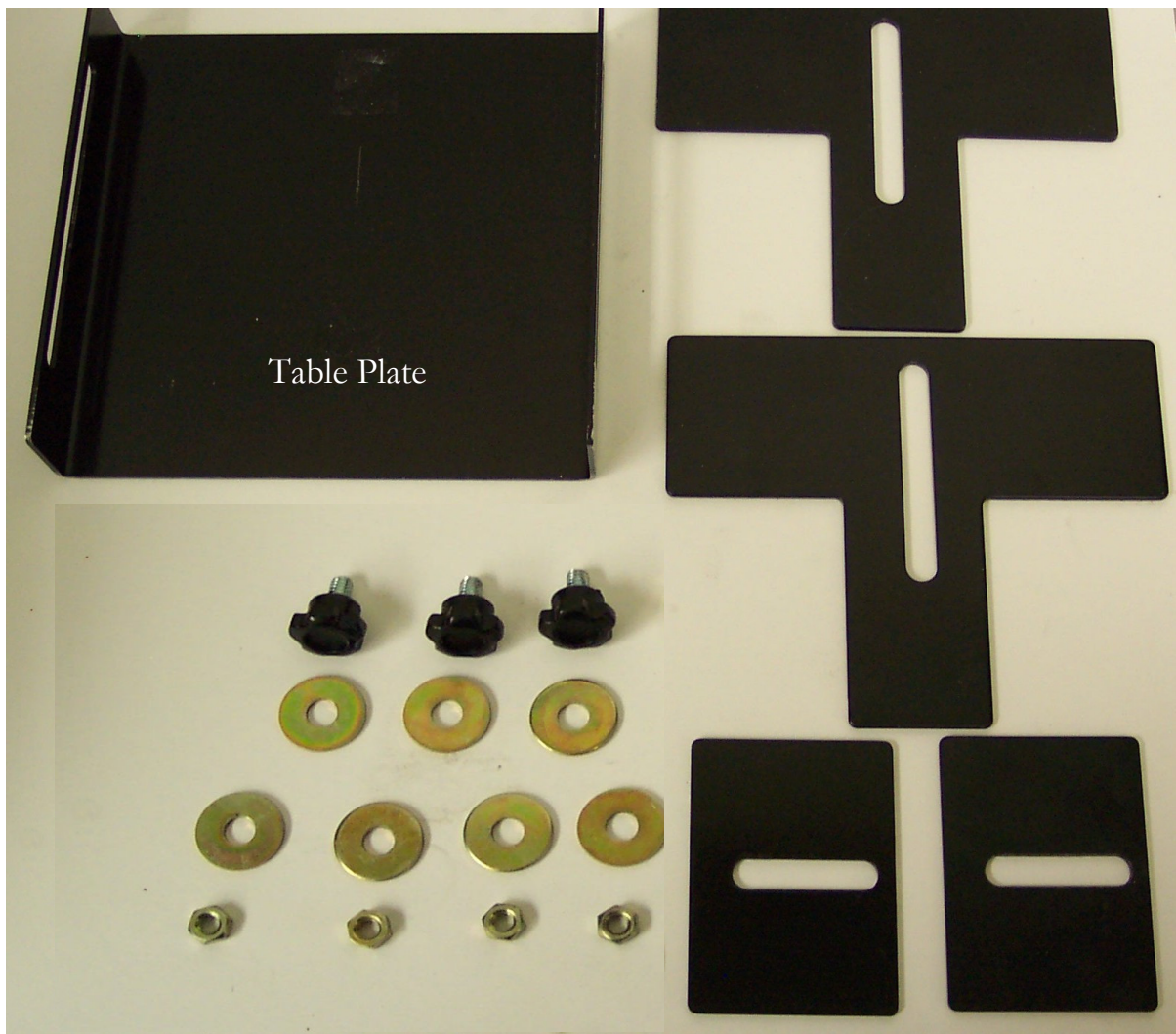

Assembling the grinder



Be sure the on/off switch is in the off position and the power cord is unplugged!!

Installing the guards

The 2 small guards install on the studs on the bottom of the stone guard on each side using one nut and one washer per stud. The guards should be adjusted at all times so they are no more than 1/4" from the stone.

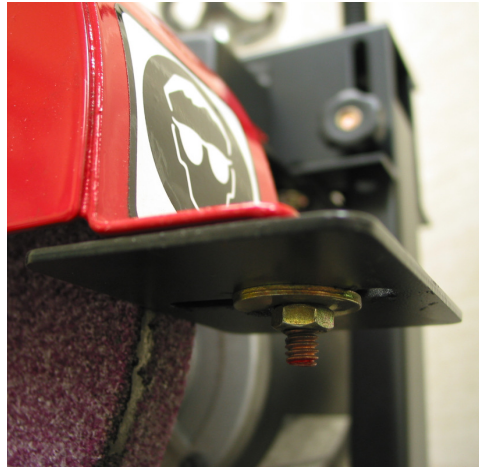
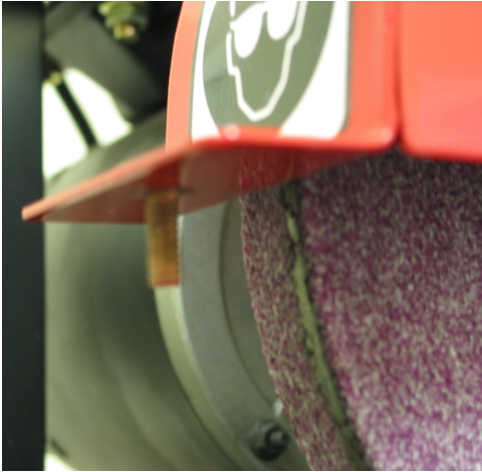

The 2 large "I" guards mount on the studs on the bottom of the main table using one washer and one nut per stud.

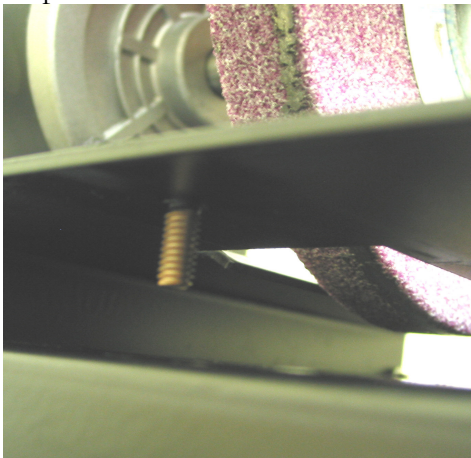

Assembling the grinder (cont.)

Installing the guards (cont.)

PLEASE NOTE: the large “T” guards are offset and only mount one direction so they slide along the angled lip in the stone opening of the main frame.

The “T” guards must be adjusted so they are no more than 1/8” from the stone.

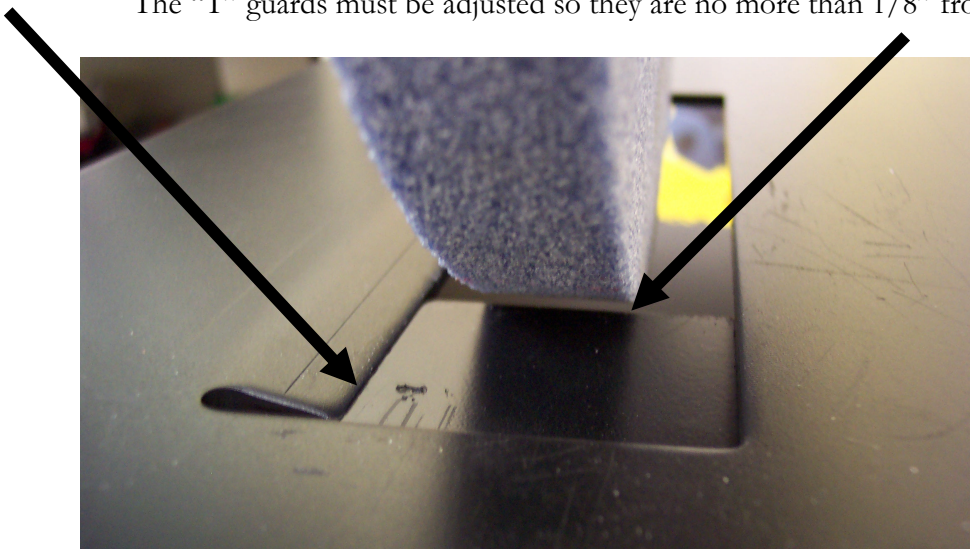

Installing the table plate

Mount the table plate on the left or right side of the table using the 3 washers and thumb screws.



Adjusting the grinding angle

In order to provide a proper grind the angle of the grinding wheel to the work rest may need to be adjusted. Adjust the angle to the original angle of the blade as provided by the OEM. This is usually 30 degrees.

1. Unplug the grinder and remove the switch safety lock while checking and adjusting the angle.
2. Place the blade to be ground on the table plate so that the bottom, or the grass side of the blade, is flat against the table plate.
3. Position the blade so that the cutting edge is against the grinding stone.
4. Visually check to see if the grinding angle is correct. If the angle is correct the stone will appear to be touching the grinding edge from the top to the bottom of the edge. If it is not touching from top to bottom the angle needs to be adjusted.

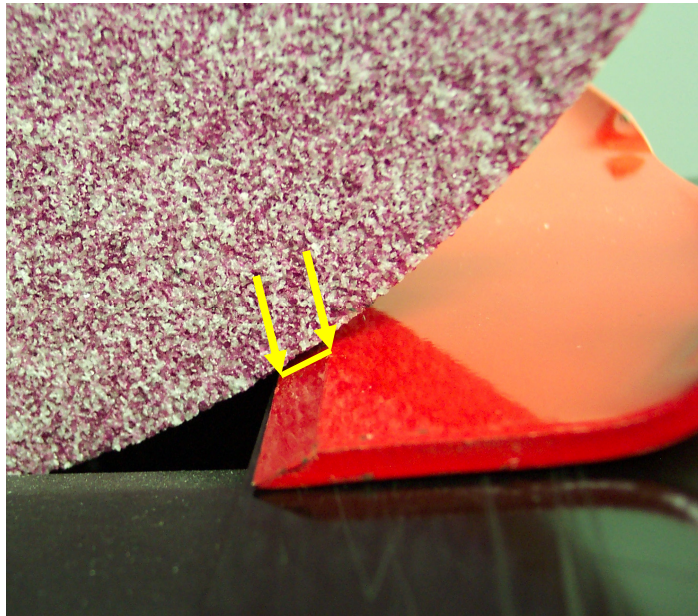

5. If the angle is correct continue on to the section on blade sharpening. If not proceed with number 6.

Adjusting the grinding angle (cont.)

6. Adjust the grinding angle by first loosening the nuts that lock the adjustment in place.

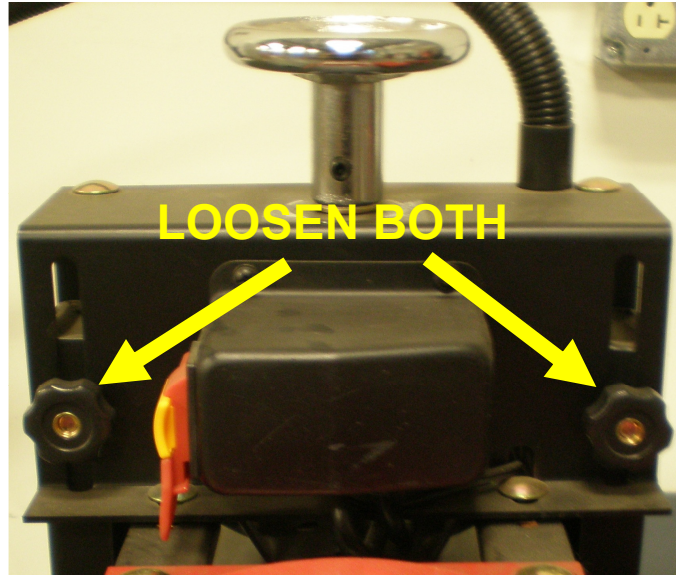

7. Turn the adjuster on top of the grinder to either raise or lower the grinding wheel creating the correct angle.
8. Turn the adjuster a little at a time and check the results as in step 4. Continue to adjust as needed.

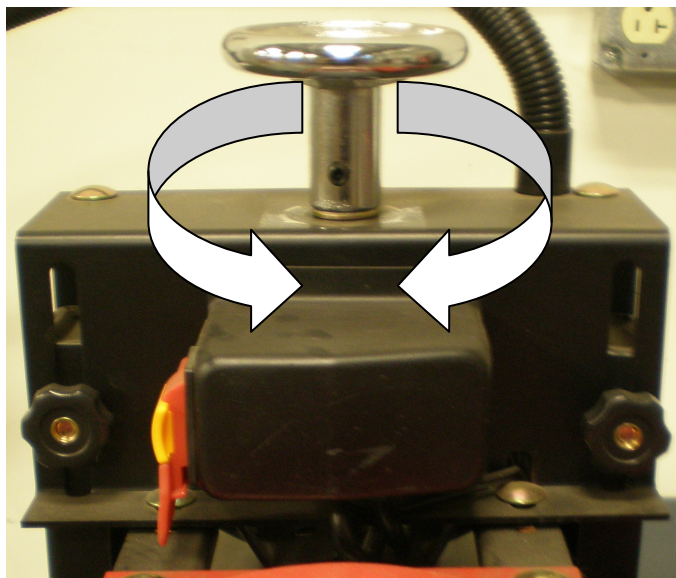

9. Once the proper angle is achieved lock the adjustment by tightening the nuts loosened in step 6.

Adjusting the table plate

After the correct depth and angle are set adjust the table plate to within 1/8" of the stone by loosening the thumb screws and sliding it toward the stone. Retighten all thumb screws.

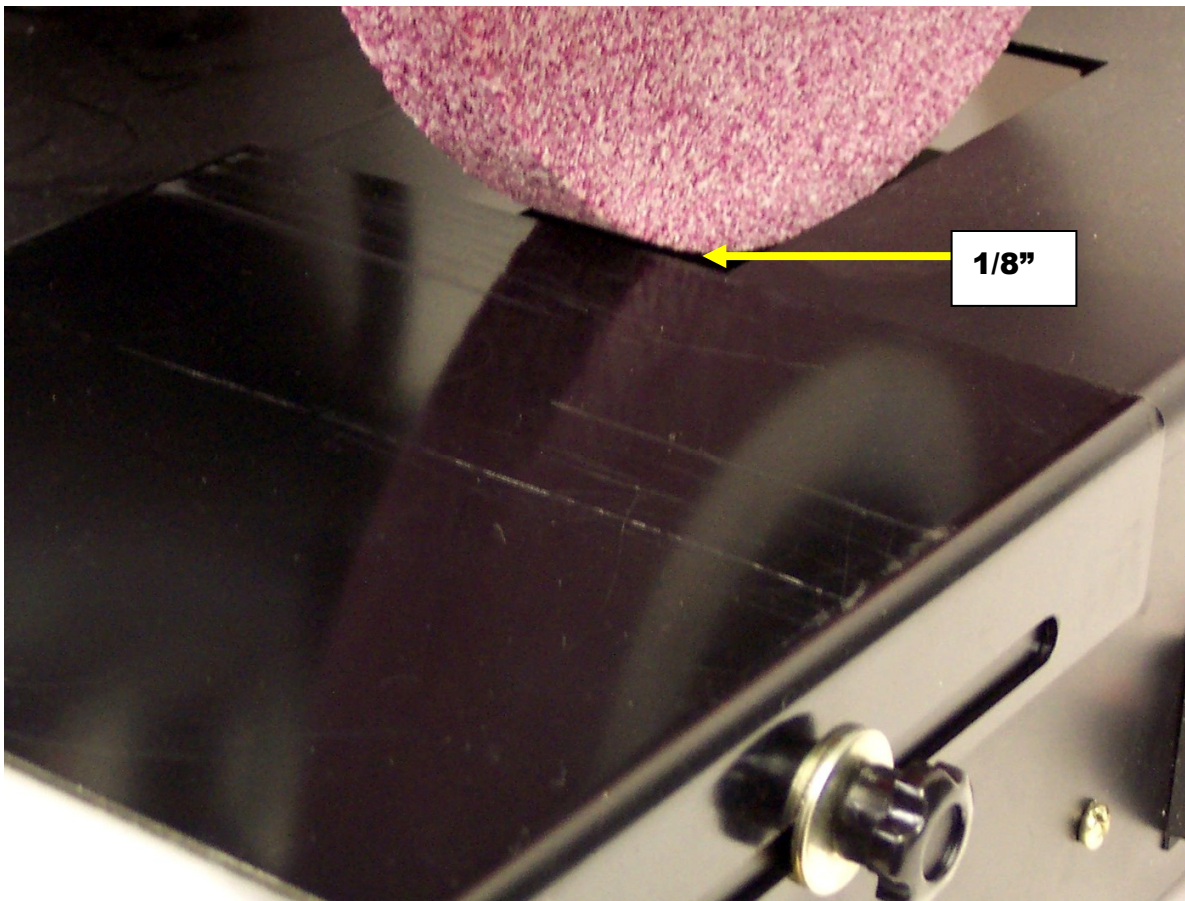

Grinding the blade



Always be sure that you have proper eye protection. A pair of safety glasses or a safety shield with the safety rating of Z87 must be worn at all times while grinding.

After all of the safety precautions have been followed and the angle has been checked and set you can prepare to sharpen your blade.

1. Determine if the blade that you intend to sharpen is a right handed or left handed blade. Do this by laying the blade on a flat surface in front of you grass side down against the flat surface. As you look at the blade stand so that it is lying directly away from you. If the cutting edge on the far end is on the right it is a right handed blade. If the cutting edge on the far end is on the left it is a left handed blade.



Right hand cut blade



Left hand cut blade

2. Place the direction switch on the grinder in the correct position. It will need to be in the forward position for a right handed blade and in the reverse position for a left handed blade.

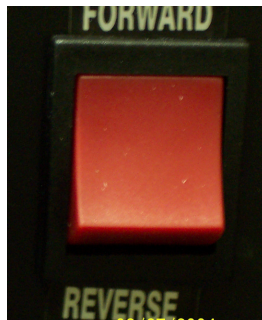

Grinding the blade (cont.)

3. Ensure that the area is safe and the grinding wheel is clear of any obstructions or loose objects.
4. While sharpening the blade stand so that the face of the grinding wheel, not the edge used to sharpen, is in front of you. This keeps you away from the path of anything that may be thrown from the grinding wheel.
5. Place the safety lock pin in the power switch.



6. Turn switch to the on position.
7. Hold the blade with two hands on the end opposite of the one you intend to sharpen.
8. Carefully place the blade on the work table grass side down.
9. Move the cutting edge of the blade toward the grinding wheel. The grinding surface of the wheel and the cutting edge should be kept parallel.
10. Once the cutting edge and the grinding wheel are in contact with each other begin to move the blade back and forth from the beginning to the end of the cutting edge. Keep a steady pressure against the blade.

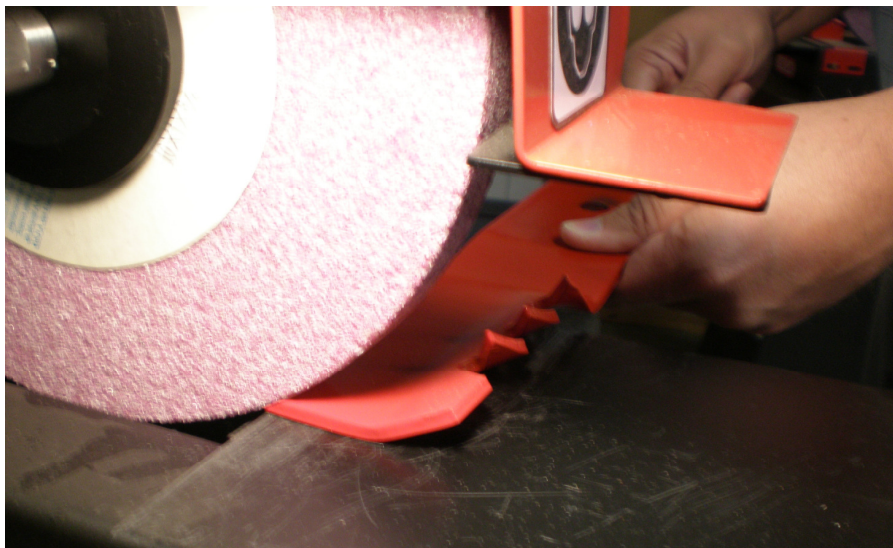

Grinding the blade (cont.)

11. Continue this motion until the edge is sharp

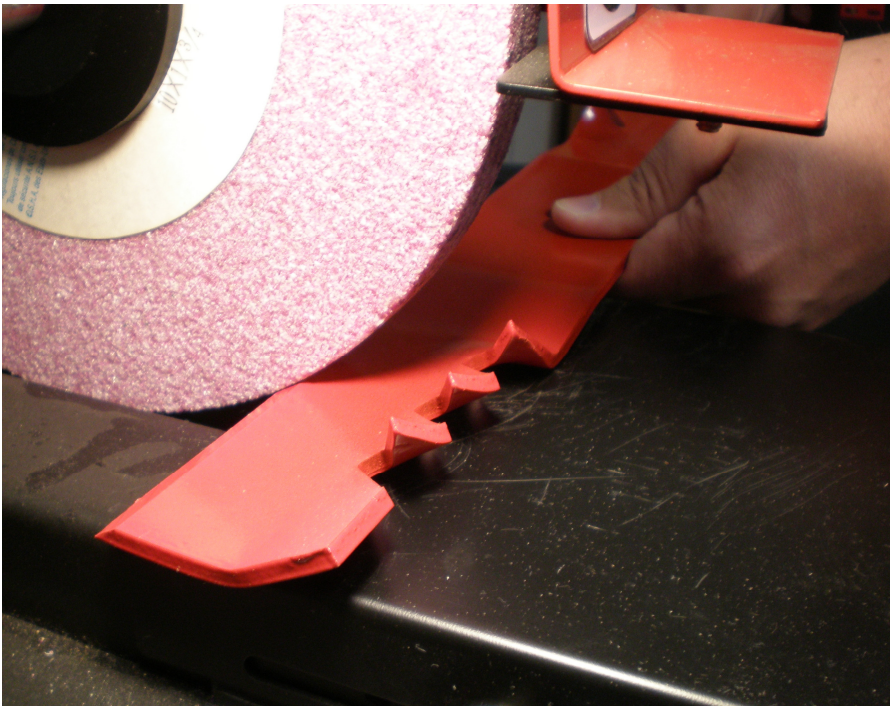
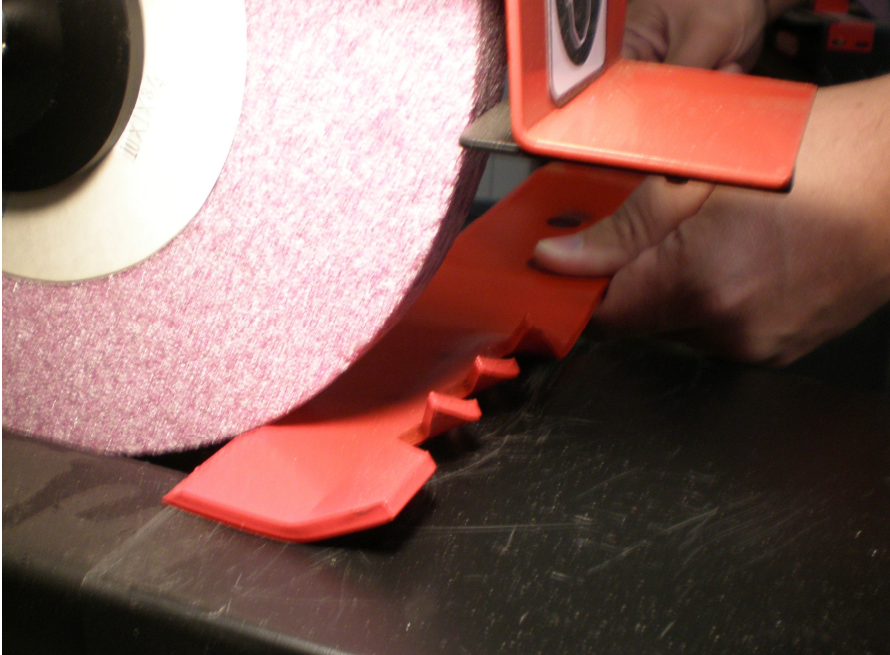

Grinding the blade (cont.)

12. Do not sharpen the blade with so much pressure as to overheat the blade and turn the metal blue. This can cause changes in the properties of the metal the blade is made from.
13. After sharpening one cutting edge of the blade hold it from the opposite end. Be careful of the sharp edge and the possibility that the blade may be hot.
14. Repeat the process used to sharpen the first edge.
15. Turn the power switch off and remove the safety lock pin.

Balancing the blade

1. Check the balance of the blade with a blade balancer such as Oregon® part number 42- 047. Slide the blade center hole onto the cone until it stops. Keeping your thumbs against the blade, pull the circular magnet forward until it makes solid contact with the blade. The magnet should hold the blade firmly.



2. Position the blade parallel with the ground. If the blade turns, dropping one tip, use the grinder and remove a little material from that cutting edge. Check and repeat the process until the blade moves very little when placed on the balancer.



Grinder Maintenance

The Oregon Blade Grinders are designed to be maintenance free. They do not require any oiling. Keep the motor clean and the grinding wheel in good shape and it should provide years of use. The grinding wheel should be replaced any time that the proper grinding angle can no longer be obtained or maximum clearance on the guards can not be achieved.

For technical service or questions regarding the grinder call 1-800-743-3150 or contact by E-Mail at techservices@oregonoep.com

Grinder exploded view

Only the parts listed below are available as replacement parts.
If you require other parts please call 1-800-743-3150 Ext 307

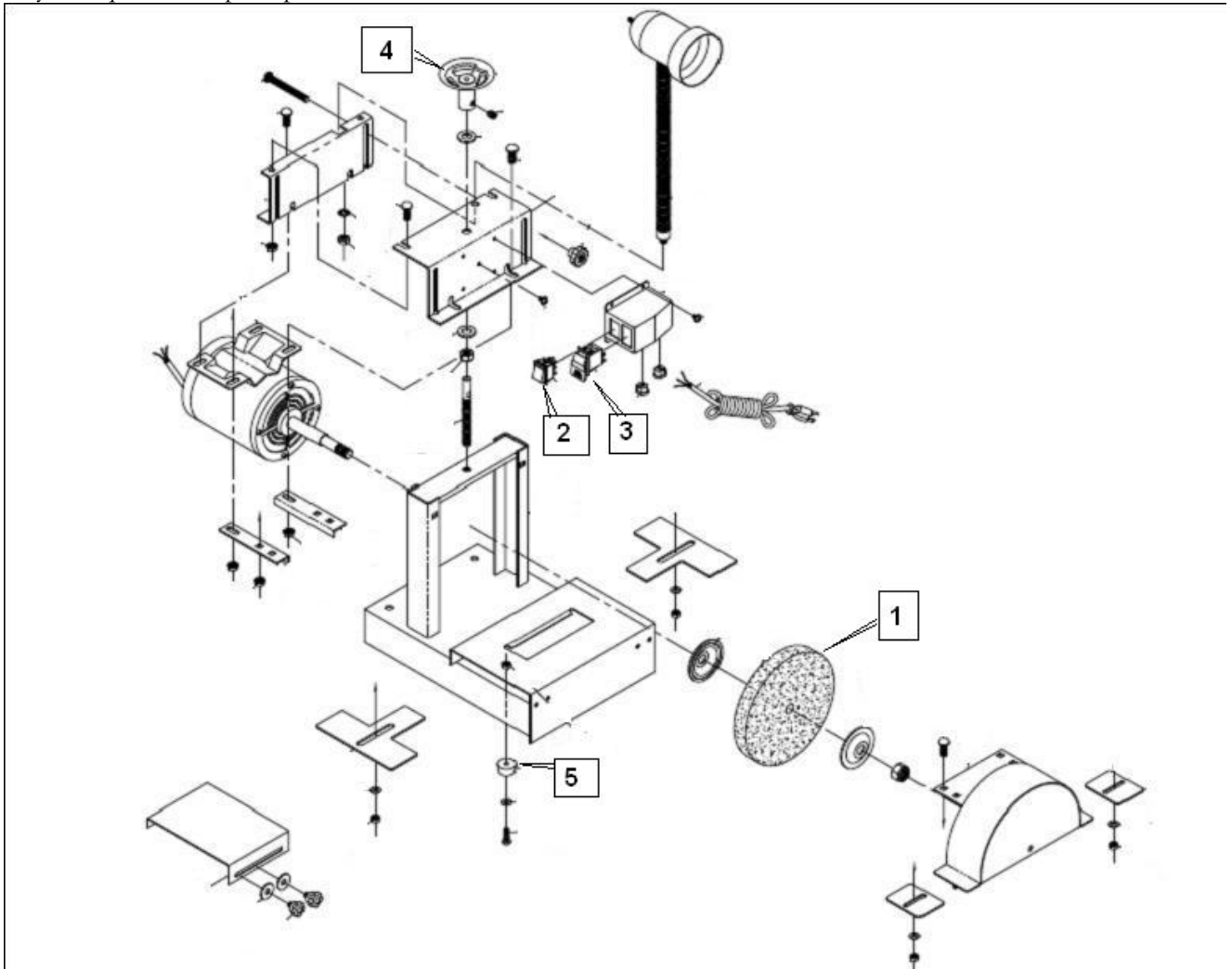

REF #	Part #	Description
1	88-048	Grinding stone 8" blue 36 grit
	88-047	Grinding stone 8" red 46 grit
2	88-012	Forward/Reverse switch
3	88-011	On/Off switch
4	88-010	Adjustment wheel
5	88-009	Rubber foot pad(4 required)
	88-067	Safety key (not pictured)
Optional Accessories		
	88-015	Mulching blade adapter
	88-037	Grit collector
	88-045	Diamond tip stoned dresser

THE OREGON® CUSTOMER-SATISFACTION POLICY LIMITED WARRANTY

The OREGON® Group of Blount, Inc. warrants its products to be free from defects in materials and workmanship for as long as they are owned by the original retail purchaser.

If you like our products, please tell your friends. If you are not satisfied with our products, for any reason, please tell us. OREGON® wants to provide you with products that perform to your full satisfaction. We welcome you to contact us as shown below.

LIABILITY UNDER THIS WARRANTY IS LIMITED TO REPLACEMENT PARTS, AT THE OPTION OF YOUR OREGON® DISTRIBUTOR AND OREGON®. PLEASE CONTACT YOUR OREGON® DISTRIBUTOR OR US DIRECTLY. OREGON® PRODUCTS ARE NOT WARRANTED AGAINST NORMAL WEAR AND TEAR, USER ABUSE, IMPROPER MAINTENANCE OR IMPROPER REPAIR.

REPLACEMENT OF DEFECTIVE PRODUCT IS THE EXCLUSIVE REMEDY UNDER THIS WARRANTY AND ANY APPLICABLE IMPLIED WARRANTY. THE REPLACEMENT WILL BE UNDERTAKEN AS SOON AS REASONABLY POSSIBLE AFTER RECEIPT OF THE DEFECTIVE PRODUCT. TO THE EXTENT PERMITTED BY LAW, ANY IMPLIED WARRANTY OF MERCHANTABILITY OR FITNESS FOR A PARTICULAR PURPOSE APPLICABLE TO THIS PRODUCT IS LIMITED TO THE DURATION AND SCOPE OF THIS EXPRESS WARRANTY. OREGON® SHALL NOT BE LIABLE FOR ANY CONSEQUENTIAL OR INCIDENTAL DAMAGES. SOME STATES DO NOT ALLOW LIMITATIONS ON HOW LONG AN IMPLIED WARRANTY LASTS OR DO NOT ALLOW THE EXCLUSION OF CONSEQUENTIAL DAMAGES, SO THE ABOVE LIMITATION OR EXCLUSION MAY NOT APPLY TO YOU. THIS WARRANTY GIVES THE ORIGINAL OWNER SPECIFIC LEGAL RIGHTS, AND YOU MAY ALSO HAVE OTHER RIGHTS WHICH VARY FROM STATE TO STATE.

OPTIONAL OEM VOID PROTECTION – If an original equipment manufacturer (OEM) refuses to honor the OEM's written warranty solely because you have purchased and used OREGON® replacement parts in the OEM's product, then OREGON® will allow you to substitute the rights and remedies provided to you under the OEM's written warranty for this express limited warranty. To be eligible for this optional OEM warranty, you must obtain from the OEM and provide to OREGON® written confirmation from the OEM that it, the OEM, has refused to honor the OEM written warranty solely because you purchased and used OREGON® replacement parts in the OEM's product.

To contact us in the U.S.A. regarding OREGON® **Forestry products** (cutting chain, guide bars, sprockets, and accessories for chainsaws and mechanical timber harvesters), we welcome your calls between the hours of 7:30 a.m. and 4:00 p.m. (Pacific Time) Monday through Friday at 503-653-4706, or you can write to: Technical Services Department, OREGON®, Blount, Inc., P.O. Box 22127, Portland, Oregon 97269-2127, or you can contact us by visiting our website at www.oregonchain.com and using the "Technical Information" or "Technical Services" links.

To contact us in the U.S.A. regarding OREGON® **Outdoor Equipment Parts** (lawnmower blades and replacement parts for small engines, lawnmowers and many other types of outdoor power equipment), we welcome your calls between the hours of 7:30 a.m. and 4:30 p.m. (Central Time), Monday through Friday at 816-231-5007, or you can write to: Technical Services Department, Oregon Outdoor Equipment Parts, OREGON®, Blount, Inc., 4840 E. 12th Street, Kansas City, Missouri 64127, or you can contact us by email at techservices@oregonoep.com.



Advanced Cutting Technology

